

1~8位 トーナメント

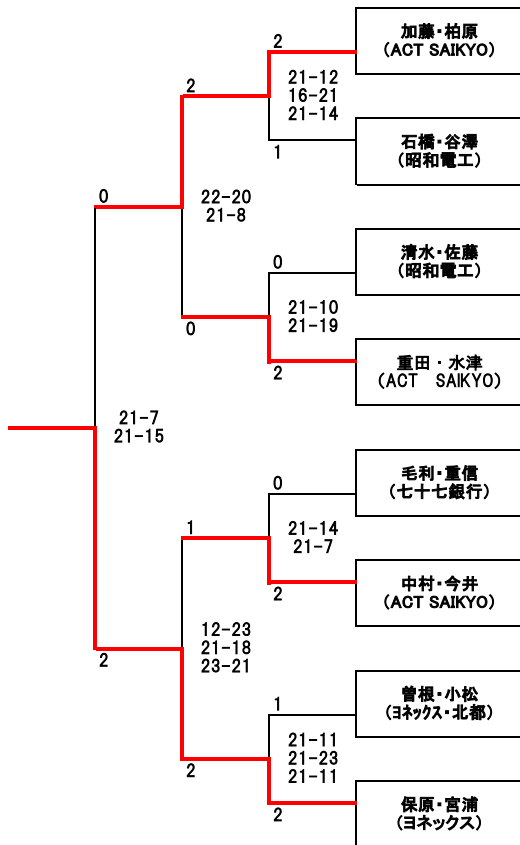

3位決定戦

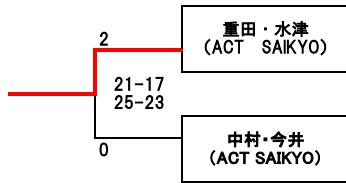

5~8位トーナメント

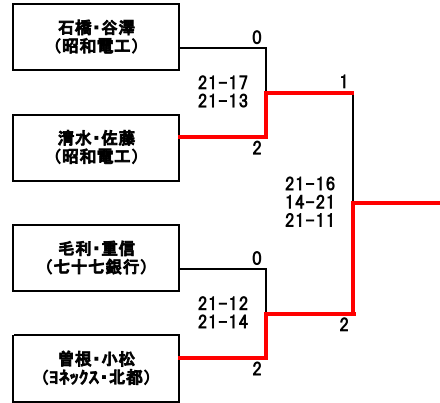

7位決定戦

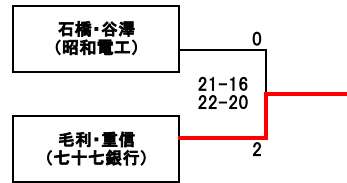

9~16位 トーナメント

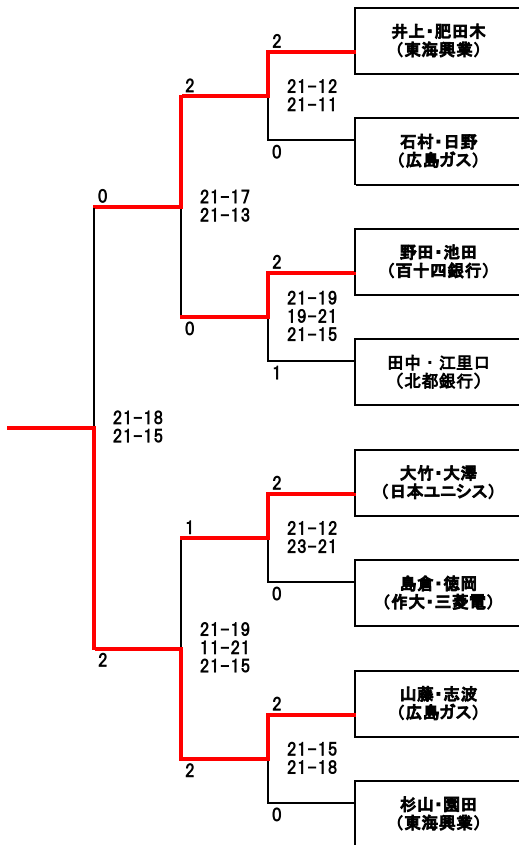

13~16位 トーナメント

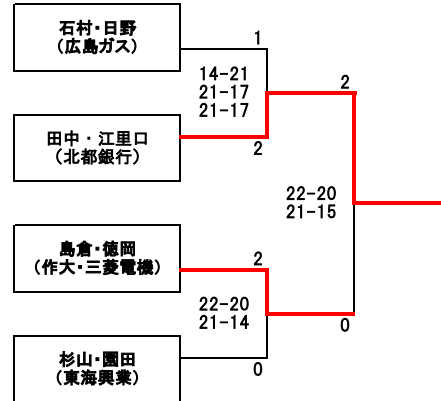

11位決定戦

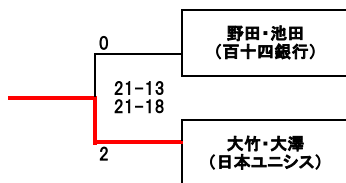

15位決定戦

